

# AQUATru<sup>®</sup>

carafe

## Quick Start Guide



# Start here to get purifying.

Let's dive in! Please follow all instructions to set up your AquaTru Carafe for the first time.

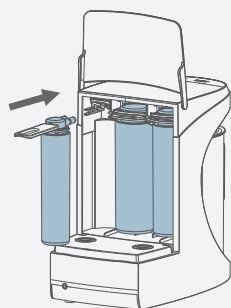

## 1. Install Filters

Remove tap water tank to access filters. Before installing the filters, remove the labels covering the base water inlet. Remove blue plugs on filter. Install all three filters with their matching color-coded base by sliding them in fully, then pressing down on the filter lock until you feel it snap into place.

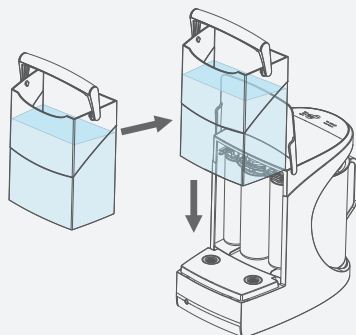

## 2. Preparing to Purify

Wash both the tank and carafe with soap and water. Fill your tap water tank with cold (never hot) tap water until water level is just below the handle. Place on AquaTru base.

## 3. Power Up

Unpack and plug in power adaptor to wall. Connect to outlet on the back of the unit. Make sure glass carafe with lid is in place. Purification will start automatically.

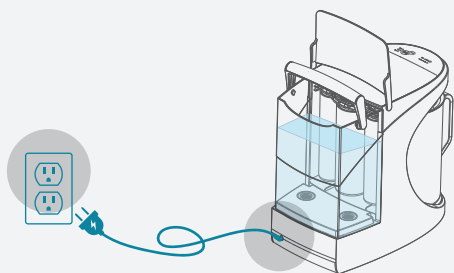

4x



EMPTY & REFILL  
TAP TANK

## 4. Empty & Repeat

Once it has stopped filtering and you see the "Empty & Refill" light turn on, empty water with concentrated contaminants from tap tank and refill with fresh tap water. Complete this process a total of four times before consuming water.



Never "top-off" leftover water.  
Always empty & refill with fresh water.

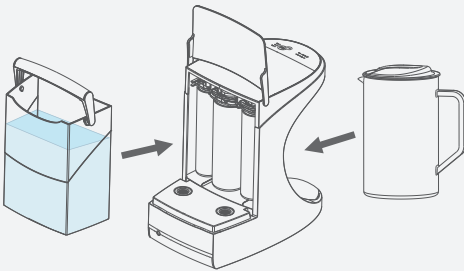

## 5. Wash, Dry, Refill

Empty tap tank and glass carafe, wash both with soapy water, then dry. Fill tap water tank with fresh tap water and place tank and carafe on the base.

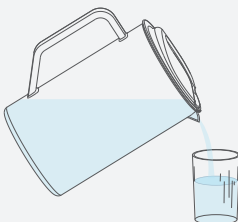

## 6. Sip Sustainably

Water you waiting for? Use your AquaTru water for all of your hydration and culinary needs, while you feel good about all of that plastic waste you're keeping out of our oceans and waterways.

## TRU Tips:



The first cycle of water may take longer than the normal 10-15 minutes. New filters take time to become fully saturated and efficiently filter water when first installed.



You may notice bubbles or cloudiness in the tap tank when purifying. This is simply trapped air releasing from filters. Any black cloudiness is loose carbon dust from your new filter as it fully saturates. Keep calm and keep purifying!



Wash both tap tank and glass carafe weekly to keep your water pure and clean.



## Waste Water Warning

### Always empty waste water before refilling tap tank

Why? AquaTru Carafe works by recirculating water many times through its purification process, which creates concentrated contaminants AKA “waste water” that is returned to the tap tank to be discarded.

Failure to discard this highly concentrated waste water will not only cause contaminants to form scale on internal parts, causing product failure, but may also void your warranty.

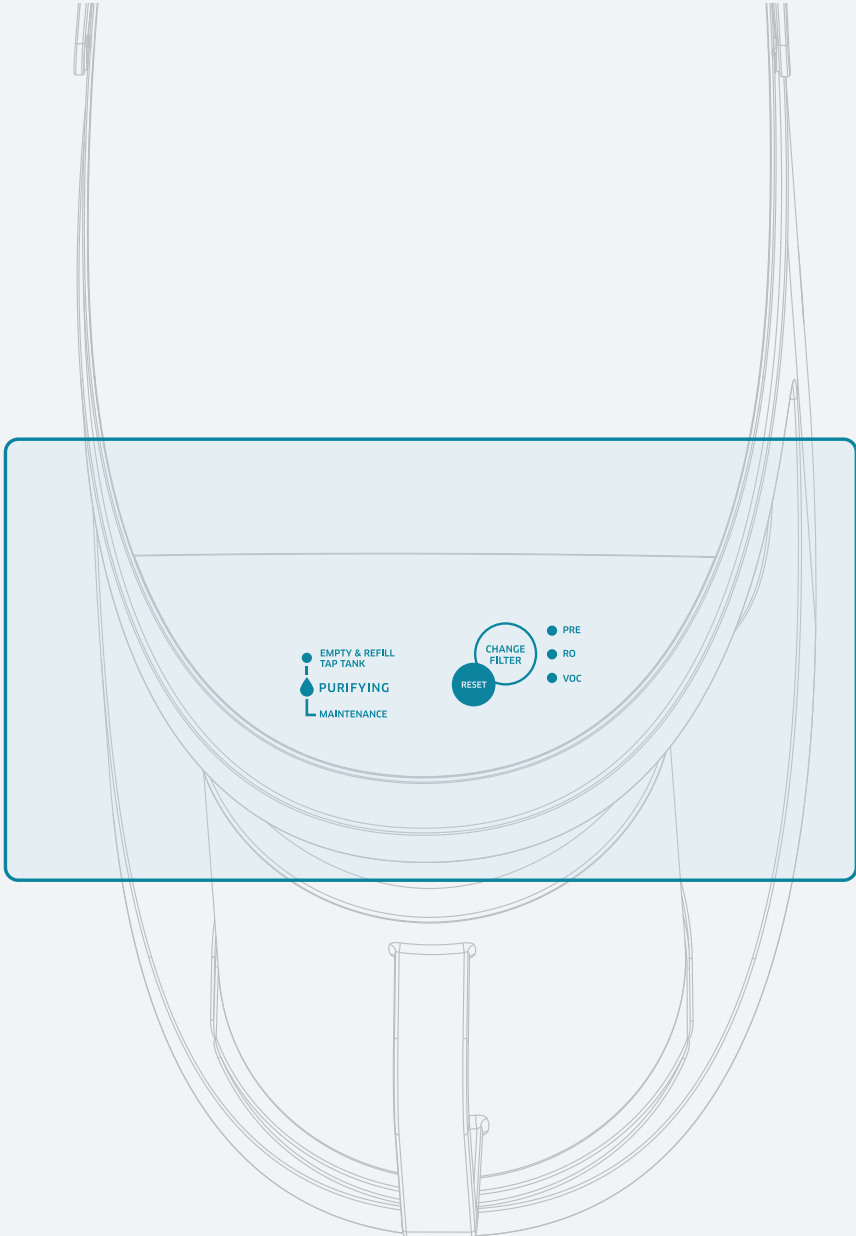

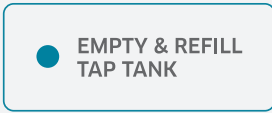

### Empty & Refill Tap Tank

Illuminates when you need to empty waste water in your tap tank and refill with fresh water before returning to the base.



### Purifying

Glow to let you know your AquaTru is hard at work transforming your tap water.

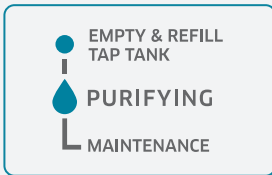

### Maintenance

When lights in both "Empty & Refill Tap Tank" and "Purifying" illuminate, descaling maintenance needs to be completed. Please refer to manual.

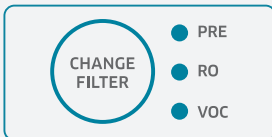

### Change Filter Alerts

When it's time to change a filter, the Change Filter indicator and the filter that needs replacing will illuminate.



### Reset

Use this button to reset filter life tracking after you have changed a filter. If the Change Filter indicator light is on, simply hold the reset button for 5 seconds until the light blinks faster and then turns off. If you change a filter before the indicator light comes on, the process is a little different. Please follow detailed steps in your manual.

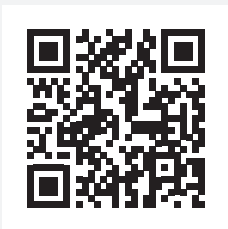

### Prefer videos? Scan code

Check out our onboarding videos

[aquatru.com/carafe-onboard](https://aquatru.com/carafe-onboard)

## Transform Water, Transform Lives

We believe an optimized life starts with access to clean water. Every time you buy an AquaTru product, we donate a portion of our proceeds to help communities most in need of access to clean water across the U.S.

We never water down the truth about water injustices across this country, and we invite you to join us in being compassionate, genuinely righteous, **TRU water warriors** for the greater good.



Scan code to Learn more

[aquatru.com/impact](https://aquatru.com/impact)

AquaTru.com  
AquaTru<sup>®</sup>, LLC  
Sherman Oaks, CA 91403  
800.220.6570

**Show us how  
you AquaTru!**

Tag and follow us  
@aquatru

**#TRUwaterwarrior**

